

# BPM Core

Smart blood pressure monitor, with ECG & digital stethoscope

Installation and Operating Instructions



# Table of contents

---

<b>Minimum requirements</b> .....	<b>5</b>
Internet access.....	5
Smartphone or device .....	5
OS version.....	5
Health Mate app version .....	5
<b>BPM Core description</b> .....	<b>6</b>
Overview.....	6
Box contents.....	6
Product description .....	7
<b>Setting up BPM Core</b> .....	<b>8</b>
Installing the Health Mate app .....	8
Installing BPM Core .....	8
<b>Using BPM Core</b> .....	<b>17</b>
Positioning myself before and during the measurement .....	17
Taking a measurement.....	18
<b>Electrocardiogram recording (ECG)</b> .....	<b>21</b>
Frequently asked questions about electrocardiogram.....	21
Frequently asked questions about Atrial Fibrillation (AFib) .....	21
Recording my electrocardiogram (ECG).....	22
Analysing my ECG recordings .....	24
<b>Digital stethoscope</b> .....	<b>26</b>
Frequently asked questions about digital stethoscope .....	26
Frequently asked questions about valvular heart disease (VHD).....	26
<b>Understanding my blood pressure measurements</b> .....	<b>27</b>
Viewing the history of my measurements .....	29
Getting more insights about my blood pressure (iOS only).....	30
<b>Managing my data</b> .....	<b>33</b>
Sharing my data with my doctor.....	33
Sharing my data with Apple Health.....	37
Sharing my data with Google Fit .....	38

Deleting data.....	39
Dissociating BPM Core .....	40
Cleaning and maintenance.....	42
Cleaning BPM Core.....	42
Recharging BPM Core.....	42
Factory resetting BPM Core.....	42
User guide copyright.....	44
Medical device .....	44
Personal data.....	44
Safety instructions.....	45
Use and storage .....	45
Safety .....	45
Service and maintenance .....	45
Cautions.....	46
Specifications .....	47
Document release overview .....	49
Warranty.....	50
Regulatory statements .....	51

## Important notice



By using your BPM Core you expressly agree to the Withings Services Terms and Conditions available on our [website](#).

# Minimum requirements

---

## Internet access

Access to the Internet is required to:

- Download the Health Mate app,
- Set up your BPM Core,
- Upgrade the firmware.

For more details, refer to ["Specifications" on page 65](#).

## Smartphone or device

An iOS device or an Android device (with operational Bluetooth Low Energy and Wi-Fi or 3G/4G) is required to:

- Set up your BPM Core,
- Retrieve data from your BPM Core,
- Interact with your BPM Core,
- Interact with people.

For more details, refer to [""Specifications" on page 65](#).

## OS version

You need iOS 10 (or higher) or Android 6 (or higher) on your device to install and run the Health Mate App.

For any device, BLE (Bluetooth Low Energy) compatibility is required to install your BPM Core.

## Health Mate app version

You always need the latest version of the Health Mate app to have all the latest features available.

# BPM Core description

---

## Overview

BPM Core is not only a highly accurate smart blood pressure and heart rate monitor, it is the first connected device that can detect, in the comfort of your home, certain valvular heart diseases and atrial fibrillation, both a variety of cardiovascular diseases frequent amongst people suffering from high blood pressure, which can help prevent serious complications from progressing.

BPM Core is our most advanced health device to date, combining medical data traditionally only available in a clinical setting with a seamless design. Along with blood pressure and heart rate monitoring, the three-in-one device records ECG, which is used to identify atrial fibrillation (AFib), a serious form of irregular heart rhythm that can lead to heart failure, fatigue and shortness of breath and is a major risk for stroke.

In addition, it provides an integrated digital stethoscope that can provide early detection of valvular heart disease, characterized by damage to one of the four heart valves that may require surgical intervention to avoid heart failure. Using the form factor of a blood pressure monitor, users can check their results in just 90 seconds along with color-coded feedback directly on the device, and they can view their complete history in the free Health Mate app via Wi-Fi or Bluetooth connection. Data can then be easily shared with doctors. BPM Core features a long battery life of up to 6 months and is rechargeable via micro USB cable.

## Box contents

- BPM Core
- Charging cable
- Instructions manual

## Product description

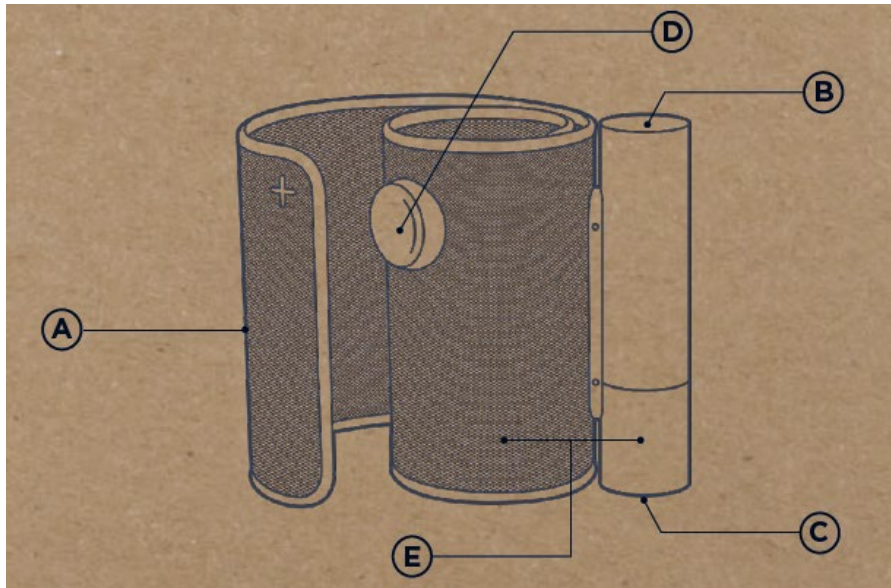

(A) Cuff

(B) Button

(C) USB plug

(D) Digital stethoscope

(E) Electrodes

# Setting up BPM Core

---

## Installing the Health Mate app

If the Health Mate app is not already installed on your device, perform the following steps:

1. Type [go.withings.com](https://go.withings.com) in your device's web browser.
2. Tap **Download** on the App Store or on the Play Store.
3. Tap **Get**.  
The installation process starts.

When a new version of the Health Mate app is available, you will automatically be prompted to update it.

## Installing BPM Core

### I'm new to Health Mate

If you don't already have a Health Mate account, you have to create one in order to set up and use your BPM Core.

If you already have an account, refer to "[I already have a Health Mate account](#)" on [page 12](#).

To install BPM Core, perform the following steps:

1. Open the Health Mate app.
2. Tap **Sign up**.

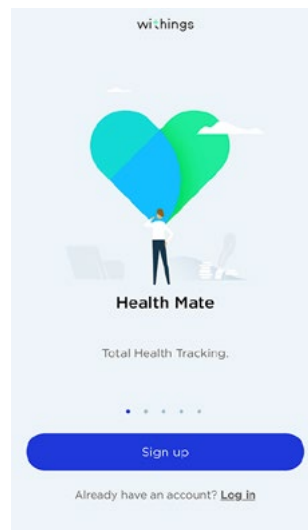



3. Tap **Blood Pressure Monitors**.

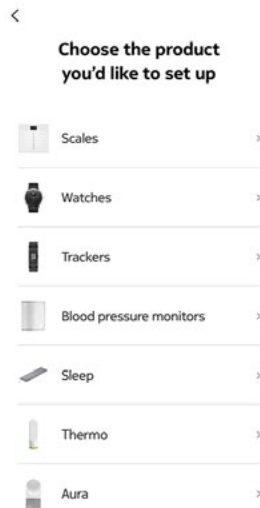

4. Tap **BPM Core**.

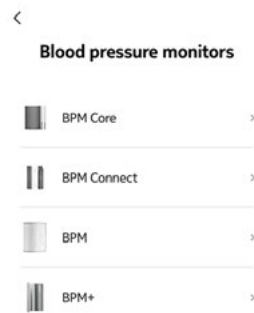

5. Tap **Install**.



6. Press and hold the button of BPM Core.

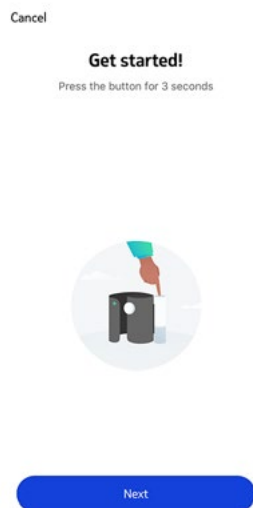

The LED of BPM Core lights up blue and "**SETUP**" appears on the screen.

7. Tap **Next**.

8. Tap **Pair**.



9. Tap **Pair** again

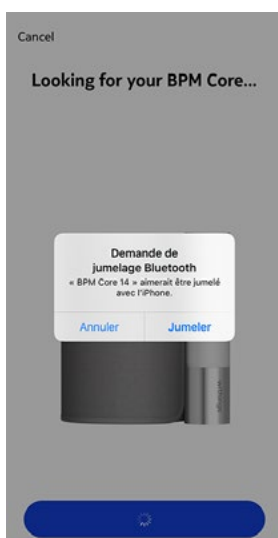

10. Tap **Next**.



11. Enter your email address, password, and then confirm your password. Tap **Next**.

12. Enter your first name, surname (last name) and birthday. Tap **Next**.

13. Select your gender and enter your current height and weight. Tap **Create**.

14. Enter the password of your Wi-Fi network and tap **Connect** if you want to install your BPM Core in Wi-Fi.

You can also tap **Choose a different network** to use another one.

15. Tap **I don't have Wi-Fi** if you want to install BPM Core in Bluetooth.



16. Tap **Done**.

Your BPM Core is ready!



Done

### I already have a Health Mate account

If you already have a Health Mate account, you can get started on the installation process. To do so, perform the following steps:

1. Open the Health Mate app.
2. Log in to your account, if you already have one, or create one.
3. Tap **Devices**.
4. Tap **+**.

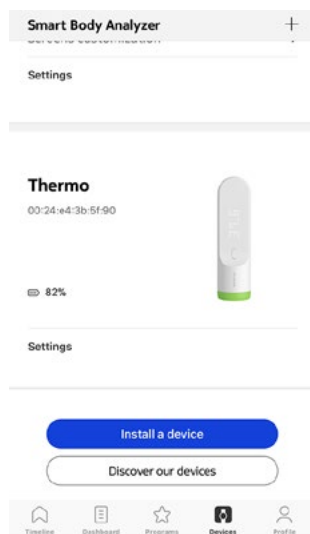

5. Tap **Blood Pressure Monitors**.

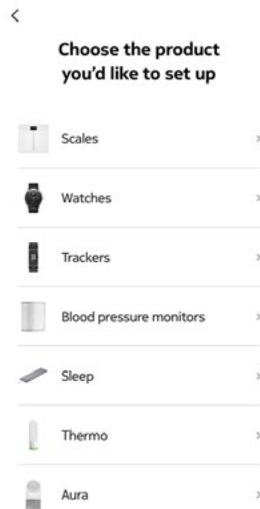

6. Tap **BPM Core**.

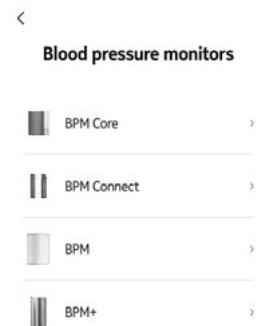

7. Tap **Install**.



8. Press and hold the button of BPM Core.

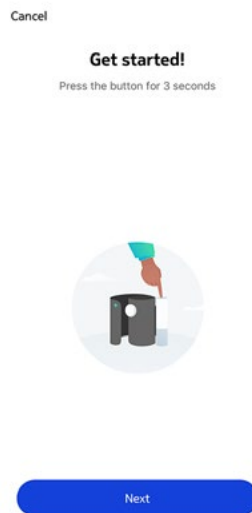

The LED of BPM Core lights up blue and "SETUP" appears on the screen.

9. Tap **Next**.

10. Tap **Pair**.



11. Tap **Pair** again.

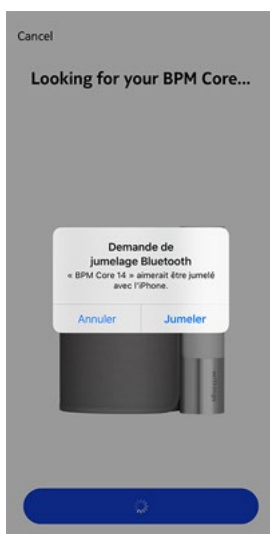

12. Tap **Next**.



13. Enter the password of your Wi-Fi network and tap **Connect** if you want to install BPM Core in Wi-Fi.

You can also tap **Choose a different network** to use another one.

14. Tap **I don't have Wi-Fi** if you want to install BPM Core in Bluetooth.



15. Tap **Done**.

Your BPM Core is ready!



Done



## Positioning myself before and during the measurement

Make sure you follow these guidelines when taking a measurement. Failing to do so may lead to inaccurate results or cause the measurements to fail.

1. Use BPM Core on the left upper arm
2. Rest 5 minutes before the measurement.
3. Sit down in a comfortable position, legs uncrossed, feet flat or on the floor, arm and back supported.



4. Do not speak or move during the measurement.
5. You can wear one layer of clothes but it should not cover your left arm. The electrodes should be in contact with the skin.
6. Take the measurement in a calm and quiet area.

## Taking a measurement

To take a measurement, perform the following steps:

1. Wrap the cuff around your left arm. The tube should be positioned against your inner arm.  
For more information on how to position BPM Core, refer to "[Positioning myself before and during the measurement](#)" on page 17.



2. The stethoscope should be placed so that its flat surface is in contact with your chest. The electrodes should be in contact with the skin of your left arm.

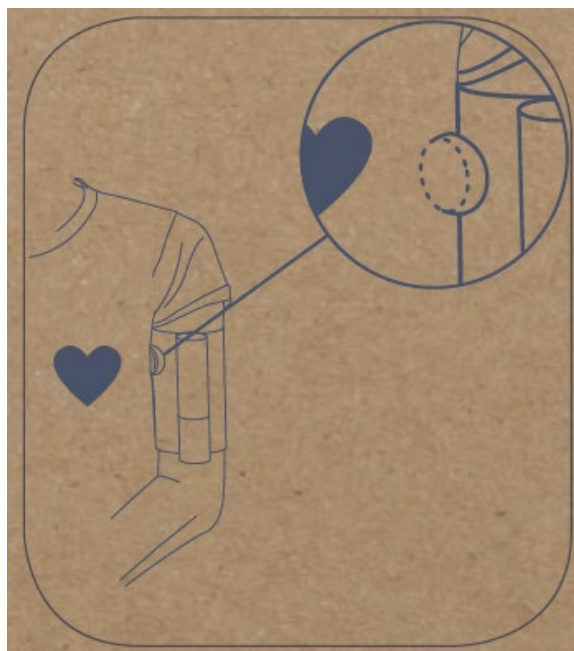

3. Place your arm on a table and keep it level with your heart.



4. Press the button to start the BPM Core.

The screen displays "**START**".

5. Press the button again to start a measurement.

**Note:** When you start a measurement, you can also select "**Start x3**" or "**ECG**" by swiping the light trail on the right part of the screen. "**Start x3**" will launch 3 blood pressure measurements in a row. "**ECG**" will only record your electrocardiogram and stethoscope signal.

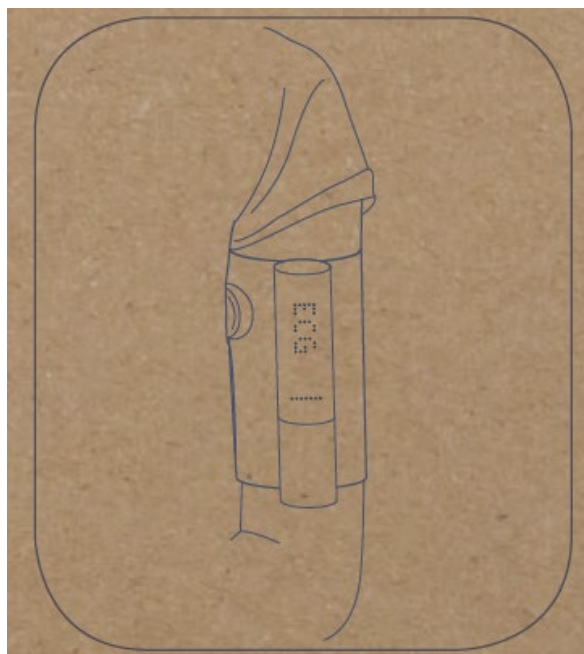

- When BPM Core displays the pictogram below, you need to place your hand on the metal tube and the stethoscope against your chest. Adjust your arm position to ensure an accurate measurement.

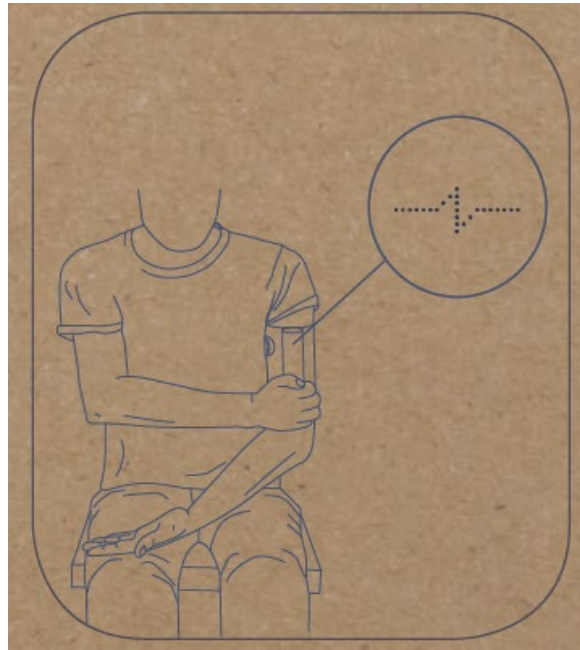

- At the end of the measurement, select the user by swiping the light trail on the right part of the screen.
- Press the button of BPM Core to validate. Results are displayed on the screen of BPM Core and sent via Wi-Fi or Bluetooth in the Health Mate app.



**Note:** If you don't place your hand on the electrode, BPM Core can't record ECG and stethoscope signal. BPM Core will only display blood pressure readings.

# Electrocardiogram recording (ECG)

---

## Frequently asked questions about electrocardiogram

### **What is an electrocardiogram (ECG)?**

An ECG is the record of the electrical activity of the heart through electrodes.

### **How BPM Core record an ECG?**

BPM Core is recording a one lead ECG, thanks to two electrodes located inside the cuff, and one electrode located on the tube.

### **Is it a medically approved recording?**

Yes, BPM Core has received CE clearance for medical devices. It is currently under review to be FDA cleared.

### **Why have you decided to integrate an ECG into a blood pressure monitor?**

With BPM Core, we wanted our users to get a chance to detect Atrial Fibrillation (AFib), that is very prevalent, often asymptomatic and complicated to diagnose in the early stage. AFib could be paroxysmal and users may not be in AFib when they go to their cardiologist even if they felt some palpitations the week before for example.

A strong link has been established between high blood pressure and AFib. Accordingly to European Society of Cardiology, hypertension predisposes to cardiac arrhythmias, including ventricular arrhythmias, but most commonly Atrial Fibrillation (AFib), which should be considered a manifestation of hypertensive heart disease. Even high blood pressure is associated with incident AFib, and hypertension is the most prevalent concomitant in AFib patients.

## Frequently asked questions about Atrial Fibrillation (AFib)

### **What is Atrial Fibrillation (AFib)?**

AFib is the most frequent form of heart rhythm disorder, it can lead to heart failure and it is a major risk for stroke. Normally, when your heart contracts it regularly and completely drains the blood, but when it contracts irregularly, some blood can stagnate, which can lead to blood clot and strokes.

### **What are the main risk factors?**

AFib is a frequent condition as populations are getting older. High blood pressure and obesity can also lead to AFib.

## What are the symptoms of AFib?

Some people who have AFib don't know they have it and don't have any symptoms. Others may experience one or more of the following symptoms: irregular heartbeat, palpitations, shortness of breath.

## Is there any correlation between blood pressure and AFib?

A strong link has been established between high blood pressure and AFib. Accordingly to European Society of Cardiology, hypertension predisposes to cardiac arrhythmias, including ventricular arrhythmias, but most commonly atrial fibrillation (AFib), which should be considered a manifestation of hypertensive heart disease. Even high blood pressure is associated with incident AFib, and hypertension is the most prevalent concomitant in AFib patients.

## Recording my electrocardiogram (ECG)

To record your ECG and stethoscope signal (heart sounds measurements), perform the following steps:

1. Make sure you follow the guidelines when taking a measurement. Please refer to "[Positioning myself before and during the measurement](#)" on page 17 for more information.
2. Push the button to start BPM Core.
3. Swipe the light trail on the right part of BPM Core until "**ECG**" appears on the screen.



4. Push the button of BPM Core to validate and launch the recording.

- Place your hand on the metal and the stethoscope against your chest. Adjust your arm position to ensure an accurate recording.



- At the end of the recording, select the user by swiping the light trail on the right part of the screen.
- Press the button of BPM Core to validate. Results are displayed on the screen of BPM Core and sent via Wi-Fi or Bluetooth in the Health Mate app.



**Note:**

- If you don't place your hand on the electrode, BPM Core can't record ECG and stethoscope signal (heart sounds measurements). BPM Core will only record and display blood pressure readings.
- The ECG measurement mode doesn't record blood pressure

## Analysing my ECG recordings

After a successful ECG recording, you will receive one of the following information:

- **Normal Sinus Rhythm:** A normal sinus rhythm means the heart is beating in a uniform pattern between 50-150 bpm.
- **Atrial Fibrillation:** AFib is the most frequent form of heart rhythm disorder, it can lead to heart failure and it is a major risk for stroke. AFib is a frequent condition as populations are getting older. High blood pressure and obesity can also lead to AFib. Some people who have AFib don't know they have it and don't have any symptoms. Others may experience one or more of the following symptoms: irregular heartbeat, palpitations, shortness of breath. If you are experiencing any symptoms or have concerns, please contact your physician.
- **Low or High Heart Rate:** A heart rate under 50 bpm or over 150 bpm affects the ECG app's ability to check for AFib. The recording is considered inconclusive.

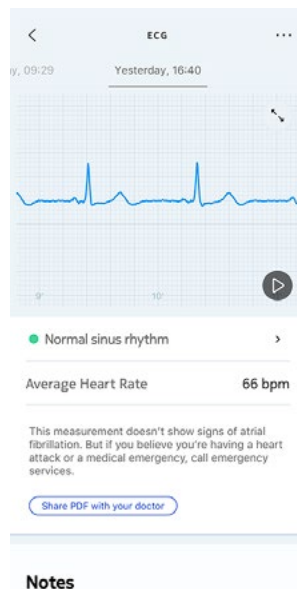

The ECG data is analyzed to determine if it is 30-seconds long, and, if so, if either Sinus Rhythm or AFib is present, or if an Inconclusive result is warranted.

Inconclusive ECG results may mean that:

- There may have been too much artifact or noise to acquire a good signal,
- You may have an arrhythmia other than AFib the app cannot classify,
- Your heart rate is below 50 bpm or above 150 bpm.
  - a. A heart rate can be low because of certain medications or if electrical signals are not properly conducted through the heart. Training to be an elite athlete can also lead to a low heart rate.
  - b. A heart rate can be high because of exercise, stress, nervousness alcohol, dehydration, infection, AFib, or another arrhythmia.



If you receive an Inconclusive result due to a poor recording, you might try to re-record your ECG. Please refer to "[Electrocardiogram recording \(ECG\)](#)" on [page 21](#) for more information.

**Important:** If you are experiencing any symptoms or have concerns, please contact your physician. If you believe you are experiencing a medical emergency, you should contact emergency services.

## Frequently asked questions about digital stethoscope

### **How does the digital stethoscope work?**

A digital stethoscope has been placed on the outer part of the cuff so that it will be in contact with the side of the chest when BPM Core is placed on the left upper arm. The device will listen to heart sounds for 20 seconds and detect if there is a risk of valvular heart disease.

### **It is a medically-approved recording?**

This recording is a big innovation and has received CE clearance for medical devices. BPM Core is currently under review to be FDA cleared.

### **What can I learn from this recording and how can I act on it?**

BPM Core tells users if there is a risk that they could have valvular heart disease, and encourage them to visit their cardiologist. The earliest the disease is diagnosed, the better the cardiologist can follow the evolution and eventually plan a surgery when needed.

## Frequently asked questions about valvular heart disease (VHD)

### **What is valvular heart disease?**

Valvular heart disease is characterized by damage to or a defect in one of the heart valves. Normally functioning valves ensure that blood flows with proper force in the proper direction at the proper time. In valvular heart disease, the valves become too narrow and hardened (stenosis) to open fully, or are unable to close completely (insufficiency).

### **What are the symptoms of valvular heart disease?**

Patients can have no symptoms but have valve disease. When symptoms occur, they are similar to those associated with heart failures, such as shortness of breath, swelling of the feet, chest pain, or palpitations.

### **Is anyone concerned about valvular heart disease?**

Valvular heart diseases are frequent conditions as populations are getting older. It has an average prevalence of 2.5% but rises sharply with age, going from 0.3% for people aged from 18 to 44 years and going to 10% for people over 65.

# Understanding my blood pressure measurements

---

## US and Canada

Compare your results to the table below to understand them better.

CATEGORY	SYSTOLIC (mmHg)	DIASTOLIC (mmHg)
Normal	< 120	< 80
Elevated	120 - 129	< 80
High blood pressure (Hypertension) Stage 1	130 - 139	80 - 89
High blood pressure (Hypertension) Stage 2	140 - 179	90 - 119
Hypertensive crisis (emergency care needed)	≥ 180	≥ 120

This classification is taken from the 2017 guidelines of the American Heart Association.

This classification is based on the values of seated blood pressure measured in a doctor's office or hospital by a healthcare professional.

International guidelines suggest that the following blood pressure readings obtained by self-measurement (measurement taken at home) indicate high blood pressure:

- Systolic blood pressure  $\geq 130$  mmHg
- Diastolic blood pressure  $\geq 80$  mmHg

## European Union and other countries

Compare your results to the table below to understand them better.

CATEGORY	SYSTOLIC (mmHg)	DIASTOLIC (mmHg)
Optimal	< 120	< 80
Normal	120 - 129	80 - 84
High Normal	130 - 139	85 - 89
Grade 1 Hypertension	140 - 159	90 - 99
Grade 2 Hypertension	160 - 179	100 - 109
Grade 3 Hypertension	≥ 180	≥ 110
Isolated systolic hypertension	≥ 140	< 90

This classification is taken from the 2018 guidelines of the European Society of Hypertension.

This classification is based on the values of seated blood pressure measured in the office or hospital by a healthcare professional.

International guidelines suggest that the following blood pressure readings obtained by self-measurement (measurement taken at home) indicate high blood pressure:

- Systolic blood pressure  $\geq 130$  mmHg
- Diastolic blood pressure  $\geq 85$  mmHg

## Viewing the history of my measurements

Your blood pressure, heart rate, ECG and heart sounds measurements are sent directly to the Health Mate app right after the measurement process.

To see detailed about your measurements, and see your full history, you have to check your data on the Health Mate app.

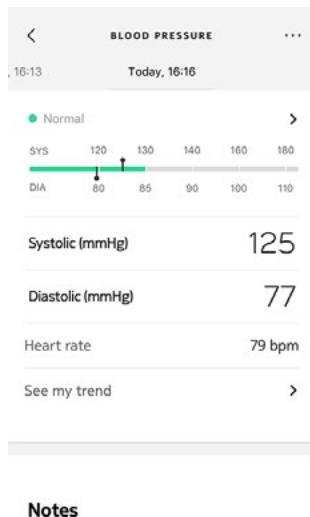

You can access your data by tapping **See my trend** in any blood pressure measurement in your Timeline. To access your heart rate measurement data, tap any item in your Timeline.

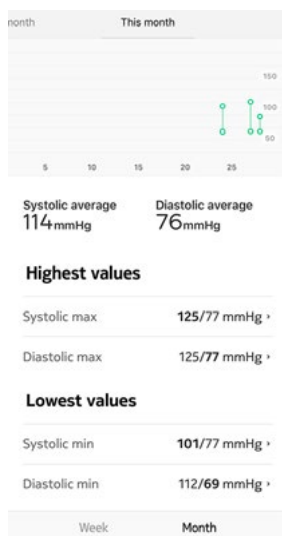

## Getting more insights about my blood pressure (iOS only)

Hy-Result is a medically validated protocol that allows you to test your hypertension from home and share the results with your doctor. It also gives you a complete and precise diagnostic about your blood pressure.

While it is a chargeable option, you can use it as many times as you'd like after the purchase.

### Purchasing Hy-Result

To get the Hy-Result function, perform the following steps:

1. Open the Health Mate app.
2. Tap **Wellness Programs**.
3. Tap **Hy-Result**.

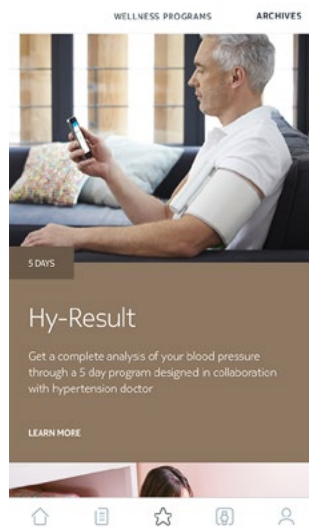

4. Tap **Join**.

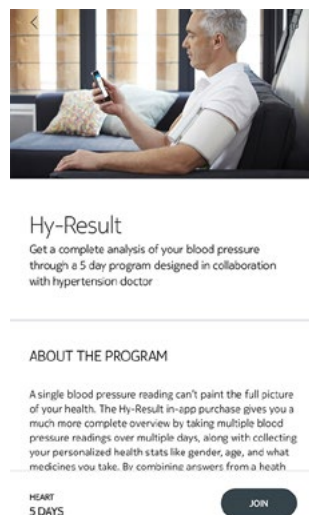

You'll have to enter your Apple ID and password to validate the purchase.

## Setting Hy-Result

Before starting the protocol, you'll have to fill in a form with various information about your health. Please note that none of this information will be shared with Withings or anyone else. Furthermore, this information will only be accessible locally on your iPhone.

Once the purchase is validated, you can start setting Hy-Result. To do so, perform the following steps:

1. Open the Health Mate app.
2. Tap **Wellness Programs**.
3. Tap **Hy-Result**.

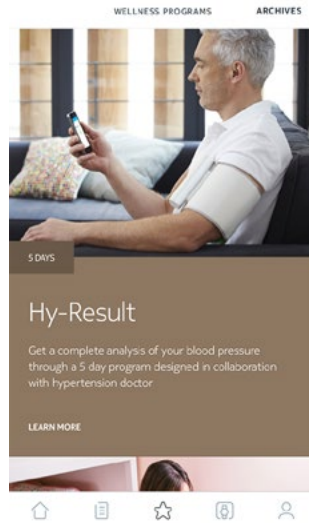

4. Tap **Join**.

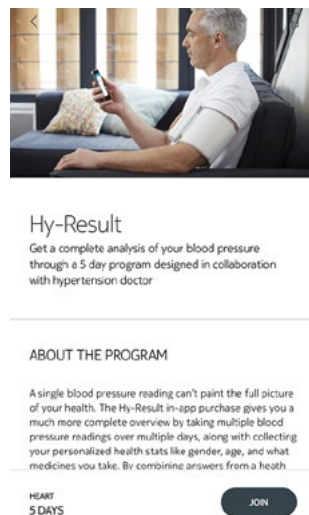

5. Set reminders to make sure you don't forget to take your measurements.
6. Fill in the form.
7. Tap **OK**.
8. Tap **Done**.  
The protocol will start the next day.

## Using Hy-Result

The Hy-Result protocol takes place over five days. During these five days, you'll have to enter three measurements per half-day (ten half-days in total). You can select one of three ways to enter these measurements:

- Enter three measurements manually
- Take three separate measurements using your BPM Core
- Take an automatic measurement using your BPM Core

To get the results, you can't miss more than two half-days of measurements. If you miss any more than that, you'll have to start the protocol over from the start.

Make sure you don't log out of the Health Mate app for the entire duration of the Hy-Result protocol. If you do, you'll have to start the protocol over from the start, as your data is only stored locally on your iPhone.

## Viewing the results

Once you have completed the Hy-Result protocol, a PDF will be created with results, containing the following information::

- Your average blood pressure with a color code
- An analysis of your hypertension, validated by medical research
- A PDF report that you can share with your doctor

You will have the opportunity to save this PDF, but for privacy reasons, if you do not save the PDF it will be deleted and you will lose your results. Note that the Hy-Result feature may be used as many times as you would like after purchase.



# Managing my data

## Sharing my data with my doctor

After recording your ECG, you can choose to send your ECG results to your doctor. To do so, perform the following steps:

1. Open the Health Mate app.
2. Select an ECG recording in your **Timeline**.



3. Tap **Share PDF with your doctor**.

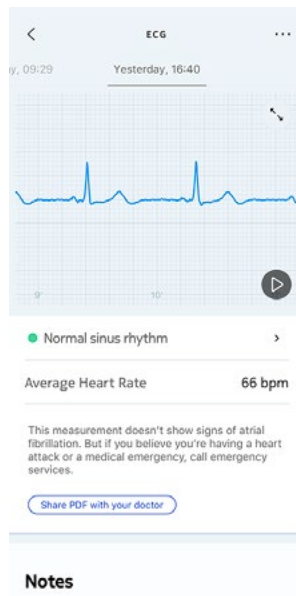

4. Tap the icon at the top right of the screen.



5. Select how you want to send your invitation. Several options are available, such as message and email. You can also choose to print your ECG record.

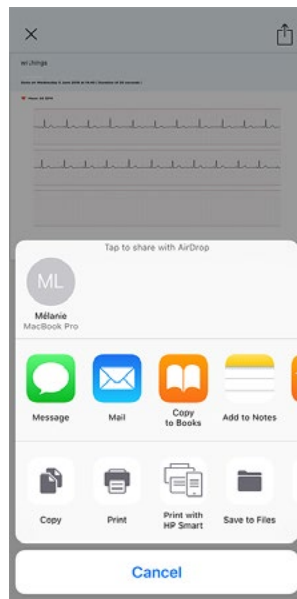

Note that you can also send your blood pressure measurements to your doctor (iOS only). To do so, perform the following steps:

1. Open the Health Mate app.

2. Select a blood pressure measurement in your **Timeline**.



3. Tap **See my trend**.

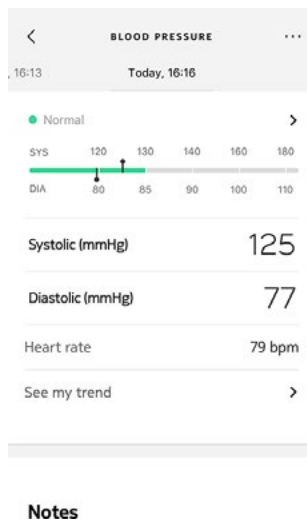

4. Tap the three dots at the top right of the screen.

5. Tap **Share with my doctor**.

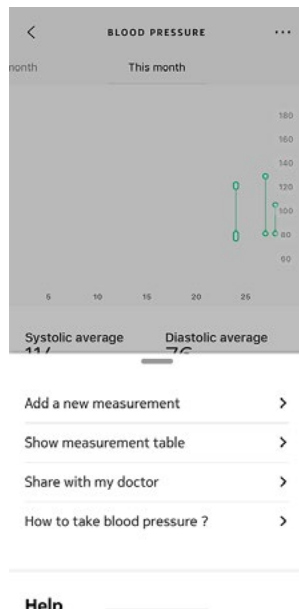

6. Enter the email of your doctor.

You can choose to send all your blood pressure measurements or the measurements over the past 3 months/weeks. You can also set a periodical reminder.

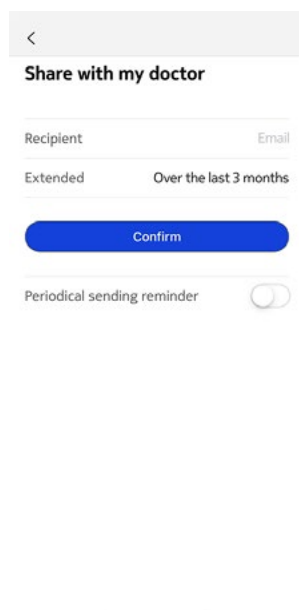

7. Tap **Confirm**.

## Sharing my data with Apple Health

The Health Mate app can share the following data with Apple Health:

- Diastolic Blood Pressure
- Heart Rate
- Systolic Blood Pressure

To link your accounts, perform the following steps:

1. Open the Health Mate app.
2. Tap **Profile**.
3. Tap **Health**.

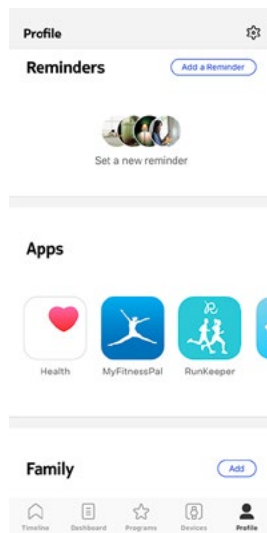

4. Select the data you want to share with Apple Health.

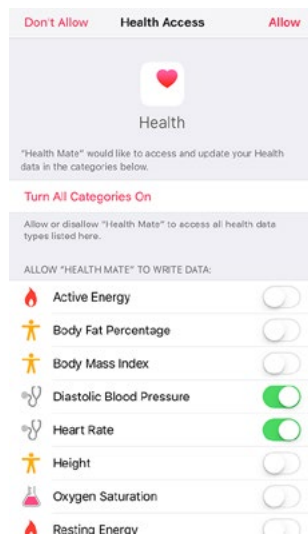

5. Tap **Allow**.
6. Tap **OK** twice.

## Sharing my data with Google Fit

The Health Mate app can share the heart rate measurements with Google Fit.

To link your accounts, perform the following steps:

1. Open the Health Mate app.
2. Tap **Profile**.
3. Tap **Google Fit**.
4. Tap the toggle to activate the Google Fit integration.

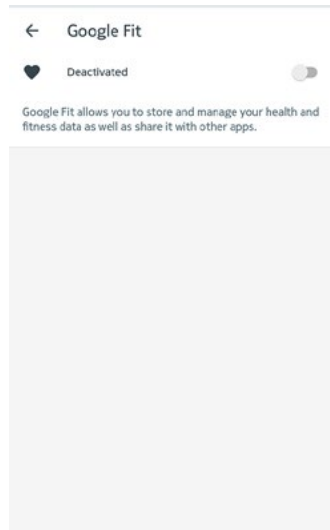

5. Select the Google account you want to link your Withings Account to.
6. Tap **OK** twice.

## Deleting data

You have the possibility to delete your heart rate and blood pressure measurements from the Health Mate app. To do so, perform the following steps:

1. Open the Health Mate app.
2. Swipe the value which you want to delete measurement.

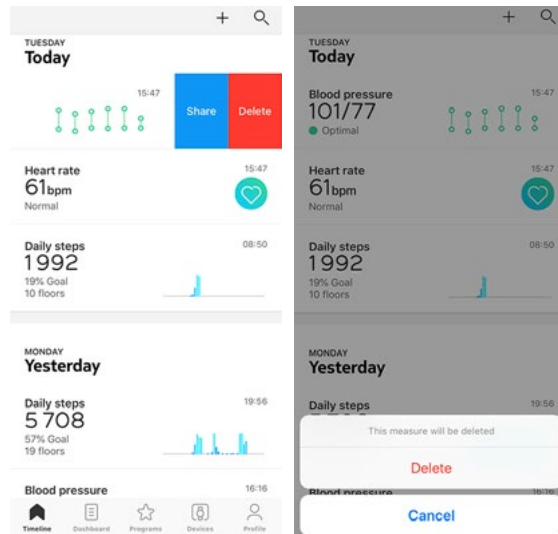

# Dissociating BPM Core

If you want to stop using BPM Core, you have to dissociate it from your account first.



**Dissociating BPM Core will not remove any of the data that was synced from the Health Mate app.**

To dissociate your BPM Core, perform the following steps:

1. Open the Health Mate app.
2. Go to **Devices**.
3. Tap **BPM Core**.



4. Tap **Dissociate this product**.

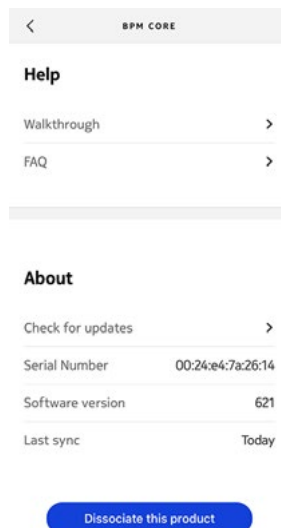



5. Tap **Remove from my account**.

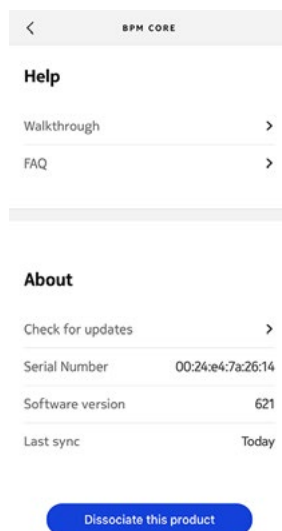

# Cleaning and maintenance

---

## Cleaning BPM Core

- Do not use an alcoholic-base or solvent agent to clean BPM Core.
- Clean BPM Core with a soft and dry cloth.
- The dirt on the cuff can be cleaned by a moisten cloth and soap.
- Do not flush BPM Core and cuff with much water.
- Do not dismantle BPM Core or disconnect the cuff or try to repair by yourself. If any problem happens, refer to the distributor.
- Do not operate BPM Core under severe environment of extreme temperature or humidity, or direct sunshine.
- Do not shake BPM Core violently.
- Do not submerge BPM Core or any of the components in water.
- Do not let BPM Core under strong shocks, such as dropping the device on the floor.

## Recharging BPM Core

You can easily charge BPM Core using the charging cable provided with the blood pressure monitor. To do so, connect the USB end of the charging cable to a power source.

## Factory resetting BPM Core

Performing a factory reset allows you to delete all of the data stored on it.

### **Important:**

- Factory resetting BPM Core. will not remove any of the data that was synced from the Health Mate app.
- All data that wasn't synced before resetting BPM Core will be lost permanently.

To do this, first dissociate BPM Core from your Health Mate account. Please refer to "[Dissociating](#)" on page 32 for more information.

Then, 'forget' or 'unpair' BPM Core from your mobile device's list of Bluetooth devices.

On iOS:

1. Go to **Settings** and select Bluetooth.
2. Select the **i** icon next to the BPM Core.
3. Select **Forget Device** to confirm.

On Android:

1. Go to **Settings** and select **Bluetooth**.
2. Select the gear icon next to the BPM Core.
3. Select **Forget** or **Remove**.

BPM Core can now be reset to factory settings. To reset BPM Core, perform the following steps:

1. Press and hold the monitor's button for 6 seconds until **Training** is displayed on the screen.
2. Use your finger to scroll up or down on the vertical bar on the monitor's display until **Reset** is displayed on the screen.
3. Press and hold the monitor's button for 2 seconds.
4. Press the button 5 times as the display counts down from **5**.  
BPM Core has now been reset.

Once the factory reset is complete, you can reconfigure your BPM Core. Please refer to "[Setting up BPM Core](#)" on [page 8](#) for more information.

# User guide copyright

---

This user guide is protected by Intellectual Property laws and copyright. Any reproduction, modification, representation and/or publication, without Withings prior approval is strictly prohibited. You may print this user guide for your personal use exclusively.

For any question please contact Withings at : <https://support.withings.com/hc/en-us/requests/new>.

## Legal notice

---



**By using BPM Core you expressly agree to the Withings Services Terms and Conditions available on our [website](#).**

### Medical device

- BPM Core is a medical device and has been validated by competent authorities.
- The Health Mate app is not a medical device. Any advice or insight given by the app cannot replace medical attention.
- Consult your physician before using this monitor if you have had a mastectomy.

### Personal data

- Make sure you have read our privacy policy, which you can find on our [website](#).
- Make sure your Withings account password is secure enough to restrict access to your account. It should be at least eight-character long, have mixed case, and use a combination of alphanumeric and special characters.
- We recommend that you protect access to the Health Mate app with an additional passcode and/or Touch ID. You can do so from the app by going to Settings in the app and activating **Touch ID** and **Passcode** (only for iOS).
- We recommend that you export your data on a regular basis to local storage on your home computer. You can do so from the Health Mate [web interface](#) by clicking your **Profile picture** > **Settings** > **User Preference** > **Download my data**.

# Safety instructions

---

## Use and storage

- Use BPM Core at temperatures between 10°C and 40°C (50°F and 104°F).
- BPM Core may be stored in a clean, dry location between -25°C and 55°C (-13°F and 131°F) when not in use.
- BPM Core is a digital monitor intended for use in measuring blood pressure, heart rate, to record a one derication ECG to detect atrial fibrillation, and uncover valvular heart diseases (aortic stenosis, aortic regurgitation, mitral stenosis).
- BPM Core is intended to be used in a human adult population with an arm circumference between 9 inches to 17 inches (22 cm to 42 cm).
- BPM Core is a medical device.
- Contact your physician if hypertensive values, AFib or VHD are indicated.
- Store the device and the components in a clean and safe location. If storage conditions are different from the usage conditions indicated in this document, please wait 30 minutes before taking a measurement.

## Safety

- Make sure you consult a doctor should the symptoms be persistent or worrying in any way.
- Do not forcibly bend the arm cuff.
- Do not inflate the arm cuff when it is not wrapped around your arm.
- Do not apply strong shocks and vibrations to the blood pressure monitor or drop it.
- Do not take measurement after bathing, drinking alcohol, smoking, exercising or eating.
- Do not immerse the arm cuff in water.
- Do not use with a pacemaker, a defibrillator or other electric implant.
- Use on adults only.
- Do not use on children or pets.

## Service and maintenance

- Do not attempt to repair or modify your BPM Core on your own.
- If you can't fix the problems using the troubleshooting instructions, request service from your dealer.
- Manufacturer will make available on requested circuit diagrams, component part lists, descriptions, calibration instructions, or other information that will assist manufacturer's staff or authorized representative for repair.
- Do not use the device while doing maintenance steps.
- If you have any issue, feel free to contact our Customer Service at: <https://support.withings.com/hc/en-us/requests/new>.

# Cautions

---

- Always consult your doctor.
- Self-diagnosis of measurement results and self treatment are dangerous.
- People with severe blood flow problems, or blood disorders, should consult a doctor before using the BPM Core.
- Cuff inflation can cause internal bleeding.
- Operational factors such as common arrhythmias, ventricular premature beats, arterial sclerosis, poor perfusion, diabetes, age, pregnancy, pre-eclampsia or renal disease can affect the performance of the automated sphygmomanometer and/or its blood pressure reading.
- BPM Core is a precision measuring equipment liable to be understood by lay user but it still should be handled with care.
- A long exposure of the device to lint, dust or sunlight might reduce its life time or damage it.
- Damaged cuff or sensor might lead to incorrect measurements.
- Parts in contact with the skin: cuff and electrodes.
- Measurements can be affected by extreme temperatures, humidity & altitude.
- Do not leave the BPM Core unattended with infants or persons who cannot express their consent.
- Do not use the BPM Core for any purpose other than measuring blood pressure.
- Do not disassemble the BPM Core.
- Do not operate the BPM Core in a moving vehicle (car, airplane).
- Do not use a cellular phone near the BPM Core.
- Do not use the device with the USB cable plugged.
- Improper continuous pressure of cuff or too frequent measurements may interfere blood flow and result harmful injury to the users. Check if the use of the BPM Core does not result in prolonged impairment of your blood circulation.
- Do not apply the cuff over the users' arm bearing a wound or medical treatment and so on, as this can cause further injury.
- Cuff should be used on the arm on the side of a mastectomy.
- Use of the BPM Core can temporarily cause loss of function of simultaneously used equipment on the same limb.

# Specifications

---

## BPM Core

- Length: 560 mm (22 in.)
- Width: 165 mm (6.4 in.)
- Height: 450 mm (unfolded) (17.7 in.)
- Weight: 430 g (0.947 lb)
- Cuff circumference: fits arm circumferences from 22 to 42 cm (9 to 17 in)

## Materials and sensors

- ECG: recorded via two stainless-steel electrodes located inside the cuff, and one on the tube.
- Digital stethoscope: silicone membrane and stainless-steel support
- Display: LED matrix screen
- Pressure sensor: gauge sensor
- Sensor: semiconductor pressure sensor

## Connectivity

- Bluetooth and Wi-Fi

## Storage and memory

- Free and unlimited storage on Withings cloud
- Up to 6 measurements can be stored on the BPM Core without synchronization in Bluetooth or Wi-Fi

## Technology

- Cuff oscillo metric method
- Measurement range: 0 to 285 mmHg, SYS 60 to 230 mmHg
- Accuracy:  $\pm 3$  mmHg or 2% of reading (pressure) /  $\pm 5\%$  of reading (pulse)
- Cuff inflation: automatic inflation with air pump at 15 mmHg/s

## Certifications

- Medical EC approved (under review to be FDA cleared)
- 2008 ANSI/AAMI/ISO 81060-2:2013, EN ISO 81060-2:2014
- FCC part B 15B: 2013

## International standards

- European Society of Hypertension (ESH) for all countries except USA and Canada
- American Heart Association (AHA) for USA and Canada

## Metrics

- Heart rate measurement range: from 40 to 180 beats per minute

## Battery life

- Up to 6 months (rechargeable) via micro-USB cable

## Compatible devices

- iPhone (4S or higher)
- Apple Watch
- iPod Touch (5th generation or higher)
- iPad (3rd generation or higher)

## Compatible OS

- iOS 10.0 or higher
- Android 6.0 or higher



# Document release overview

---

Release date		Modifications
July 2019	v1.0	First release



**The screenshots in this manual are used for explanatory purposes. Your actual screens may differ from the screenshots in this manual.**

# Warranty

---

## Withings One (1) Year Limited Warranty - BPM Core

Withings warrants the Withings branded hardware product (“BPM Core”) against defects in materials and workmanship when used normally in accordance with Withings’ published guidelines for a period of ONE (1) YEAR from the date of original retail purchase by the end-user purchaser (“Warranty Period”). Withings published guidelines include but are not limited to information contained in technical specifications, safety instructions or quick start guide. Withings does not warrant that the operation of the BPM Core will be uninterrupted or error-free. Withings is not responsible for damage arising from failure to follow instructions relating to the BPM Core’s use.

# Regulatory statements

---

## Federal Communications Commission (FCC) Statement

FCC ID: XNAWPM04

This device complies with Part 15 of the FCC Rules. This equipment complies with FCC radiation exposure limits set forth for an uncontrolled environment. End users must follow the specific operating instructions for satisfying RF exposure compliance. This transmitter must not be co-located or operated in conjunction with any other antenna or transmitter.

Operation is subject to the following two conditions:

- (1) This device may not cause harmful interference, and
- (2) This device must accept any interference received, including interference that may cause undesired operation.

This device complies with the R&TTE Directive 1999/5/CE.

A copy of the EU Declaration of Conformity is available online at <https://www.withings.com/fr/en/compliance>